

# Tävlingsplats ÖRKS

20240828

## TEKNIK LC

1. Grind
2. Enkelslalom
3. Lans ur
4. Ring
5. Lans i
6. Träbro
7. Klocka i korridor,skritt in
8. **Parallell**slalom, trav
9. Flytta mugg
10. Bord

## TEKNIK LB

1. Grind
2. Enkelslalom
3. Lans ur
4. Ring
5. Lans i
6. Träbro
7. Klocka i korridor
8. **Parallell**slalom med skrittsteg mellan bågarna
9. Flytta mugg
10. Bord

## TEKNIK LA

1. Grind
2. Enkelslalom, bibehållen höger galopp
3. Lans ur
4. Ring
5. Lans i
6. Träbro
7. Klocka i korridor
8. **Parallell**slalom, skritt i båge 2 och 4
9. Flytta mugg
10. Bord

## Speed LC, LB, LA

1. Grind
2. Enkelslalom
3. Lans ur
4. Ring
5. Lans i
6. Träbro
7. Klocka i korridor
8. **ENKEL**slalom
9. Flytta mugg
10. Bord

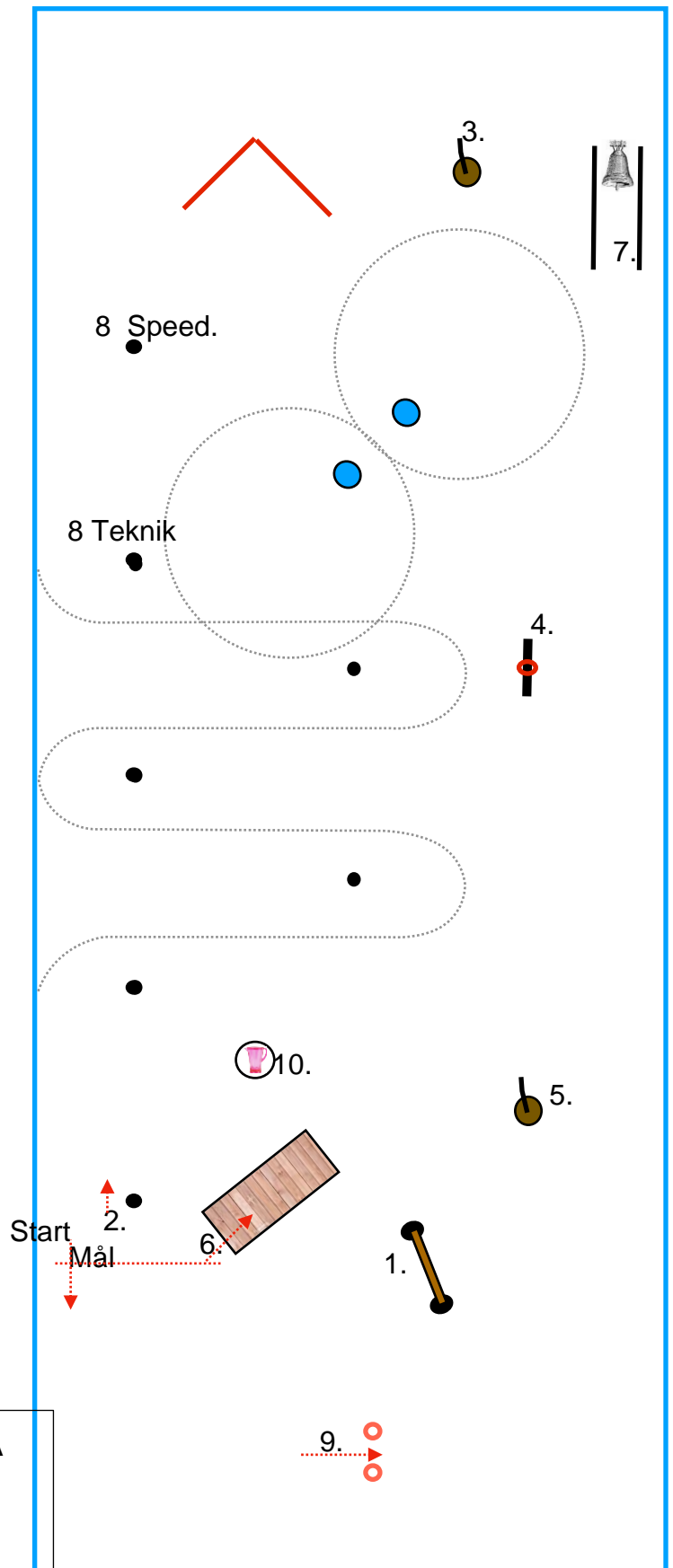

**OBS ! Hinder 8 är olika hinder i Teknik och Speed!**

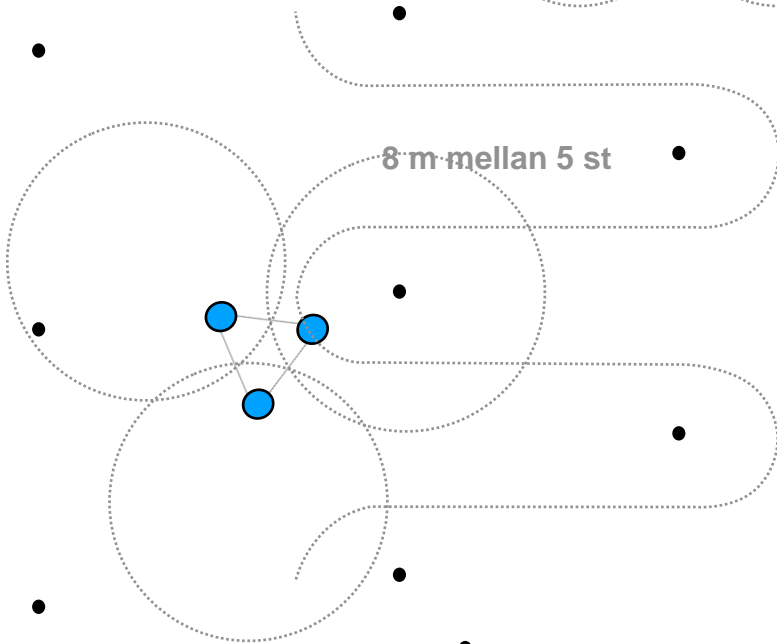
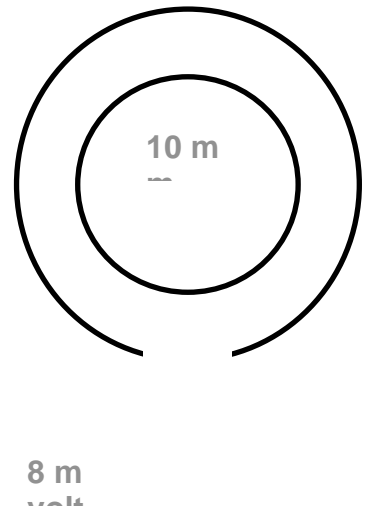
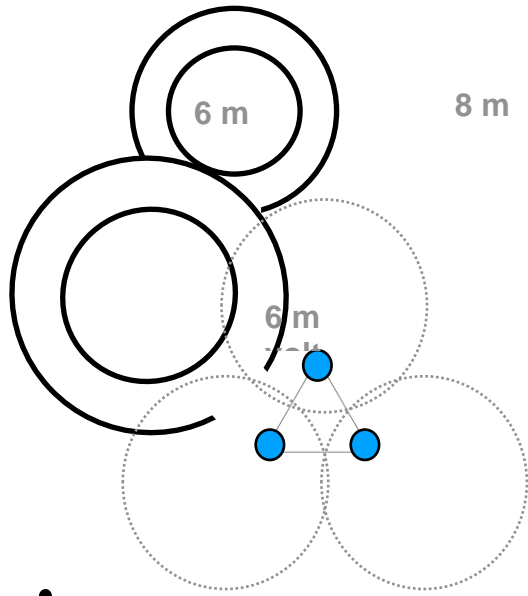

6 m mellan 5 st



8 m mellan 7 st

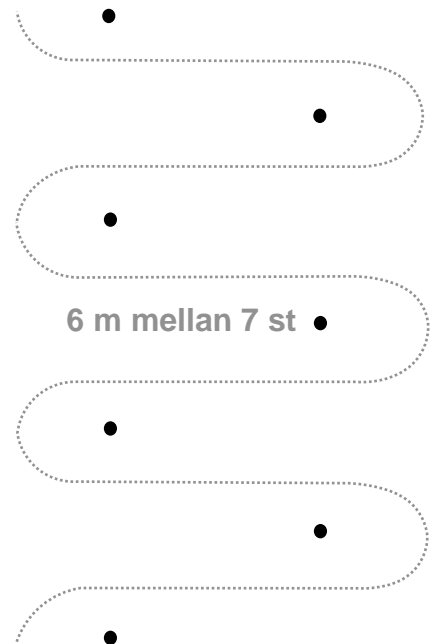
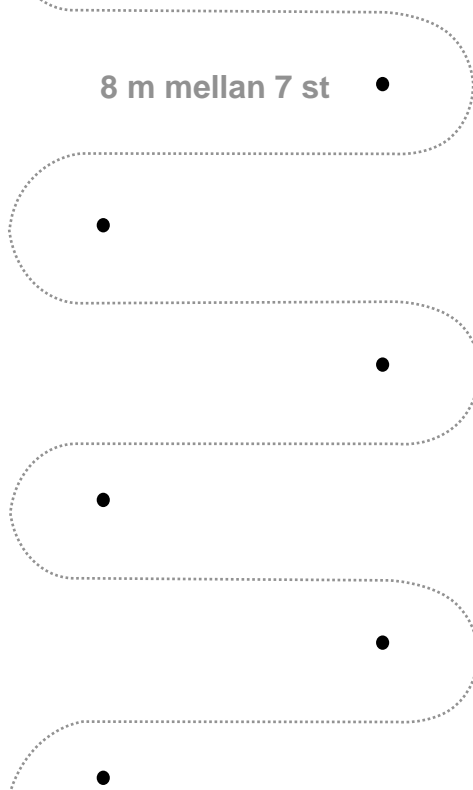
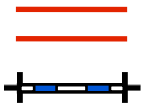

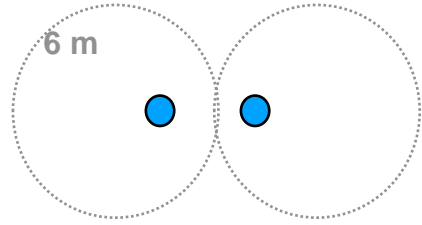
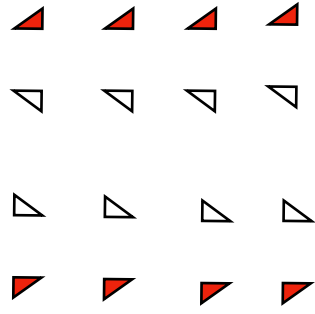
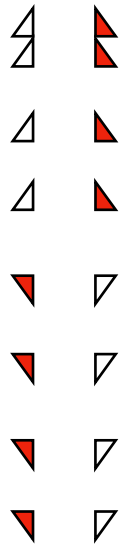

8 m

- 12.
- 13.
- 14.
- 15.
- 16.

